

PLAN MECHANICAL VIEW

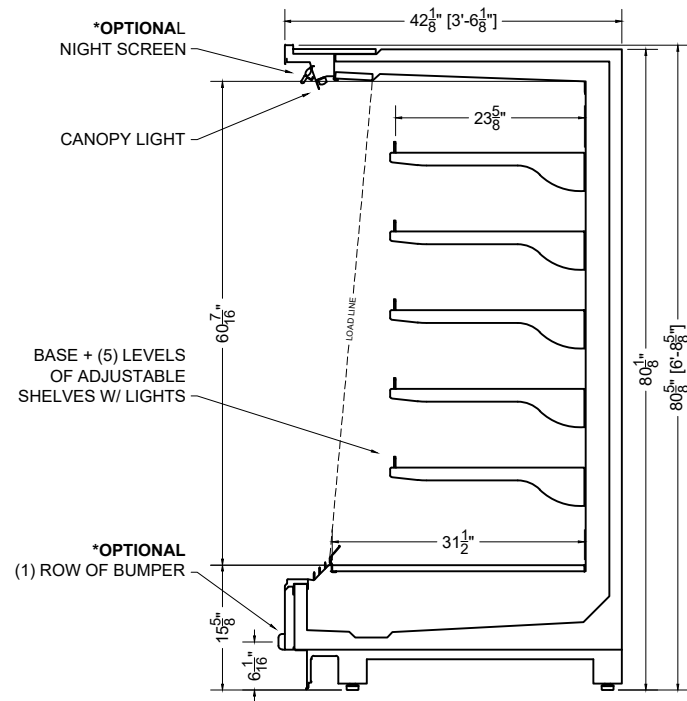

SECTION VIEW

04.1-MDC-81ADM-R

SHEYENNE

QTY	DESCRIPTION	PART NUMBER	VOLTAGE	PHASE	AMPS	TOTAL AMPS
6	45" LED 4000K 24V	LG-FX-XXX-X	115V	1	0.50	3.00
2	EVAPORATOR FAN	AFXXX	115V	1	0.20	0.40
1	DEFROST HEATERS	---	115V	1	2.17	2.17

CIRCUIT#1 (LIGHTS)	TOTAL AMPS:3.00	VOLTAGE:115/1/60	CONNECTION:HARDWIRED
CIRCUIT#2 (FANS)	TOTAL AMPS:0.40	VOLTAGE:115/1/60	CONNECTION:HARDWIRED
CIRCUIT#3 (DEFROST)	TOTAL AMPS:2.17	VOLTAGE:115/1/60	CONNECTION:HARDWIRED
MODEL:MDC-81ADM	APPLICATION:DELI	BTUH:6760	EVAP TEMP: 14°F

PACKOUT VOLUME: 50.01 CUBIC FT.  
INTERNAL VOLUME: 65.15 CUBIC FT.

PROJ SPECIFICATION SHEET

DES 04.1-MDC-81ADM-R Refrigerated Multi-Deck

NAME AME DWG# 038619 REV #02- 07/31/24

CONFIDENTIAL DOCUMENT: THIS DRAWING IS CONFIDENTIAL AND THE PROPERTY OF SOUTHERN CASEARTS, INC AND IS NOT TO BE REPRODUCED OR EXCHANGED WITH ANY OTHER PERSON OR COMPANY WITHOUT THE EXPRESS WRITTEN CONSENT OF SOUTHERN CASEARTS, INC.

COPYRIGHT ©2024 SOUTHERN CASEARTS, INC. ALL RIGHTS RESERVED

1/2" = 1'

DRAWING DETAILS SUBJECT TO CHANGE DURING THE ENGINEERING PROCESS



SOUTHERN CaseArts