

PLAN MECHANICAL VIEW

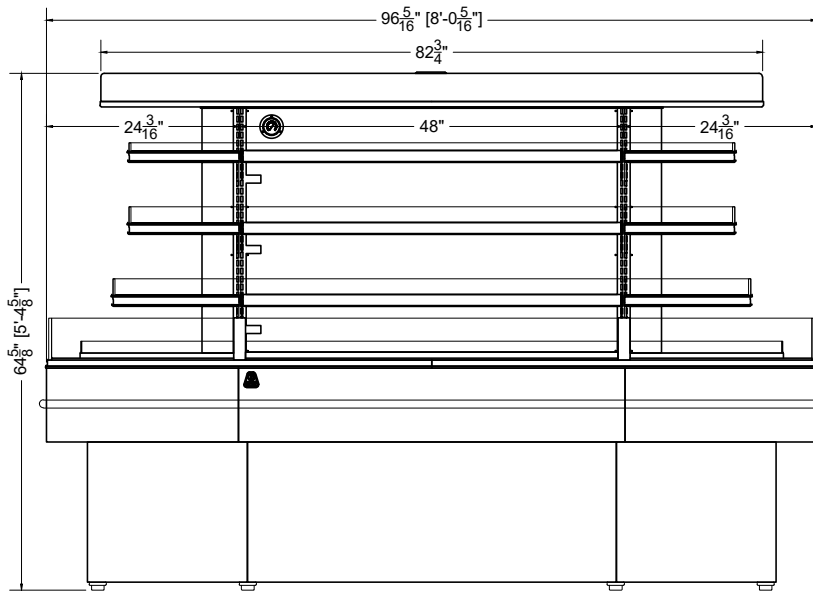

SIDE VIEW

07.9-MDI-4M2F-R = 4' CENTER + (2) FULL-RADIUS ENDS

PLACID

QTY	DESCRIPTION	PART NUMBER	VOLTAGE	PHASE	AMPS	TOTAL AMPS
8	12" LED 3500K, FROSTED, 24V	LG-FX-XXX-X	115V	1	0.02	0.16
2	18" LED 3500K, FROSTED, 24V	LG-FX-XXX-X	115V	1	0.03	0.06
8	45" LED 3500K, FROSTED, 24V	LG-FX-XXX-X	115V	1	0.09	0.72
8	EVAPORATOR FAN	AFXXX	115V	1	0.24	1.92

CIRCUIT#1 (LIGHTS) TOTAL AMPS:0.94 VOLTAGE:115/1/60 CONNECTION:HARDWIRED
 CIRCUIT#2 (FANS) TOTAL AMPS:1.92 VOLTAGE:115/1/60 CONNECTION:HARDWIRED
 MODEL:MDI-4M APPLICATION:DELI BTUH:13256 EVAP TEMP: 28°F
 DEFROST:TIME-OFF, 4/40MIN, 47° TEMP TERMINATION
 SHIPPING DIMENSIONS: 108" X 60" X 76"
 WEIGHT: 1115 LBS

PACKOUT VOLUME: 42.19 CUBIC FT.
 INTERNAL VOLUME: 54.88 CUBIC FT.

CONFORMS TO UL STD 471.
 CONFORMS TO NSF STD 7.
 CERTIFIED TO CAN/CSA STD C22.2 NO. 120.

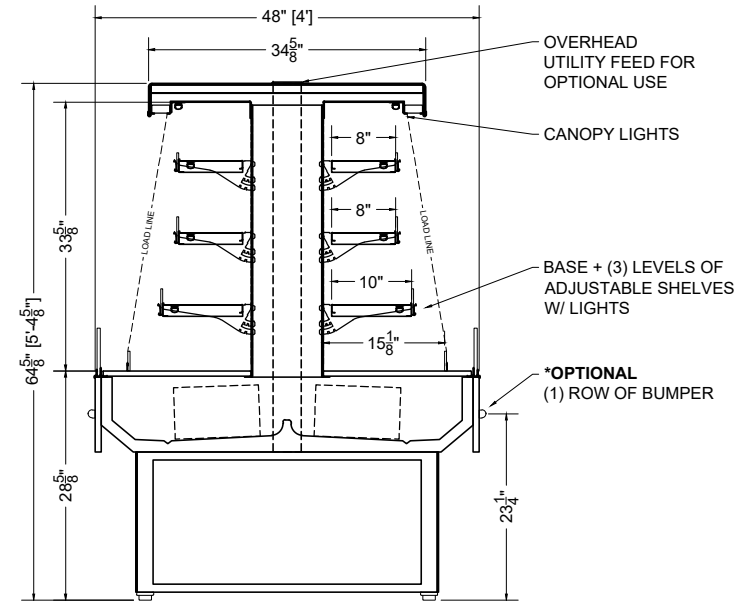

SECTION VIEW

