

PLAN MECHANICAL VIEW

04.0-MDC-83HN-R

CIMARRON

QTY	DESCRIPTION	PART NUMBER	VOLTAGE	PHASE	AMPS	TOTAL AMPS
5	45° LED 3500K, FROSTED, 24V	LG-FX-XXX-X	115V	1	0.09	0.45
2	EVAPORATOR FAN	RF-FA-XXXX	115V	1	0.17	0.34

CIRCUIT#1 (LIGHTS) TOTAL AMPS:0.45 VOLTAGE:115/1/60 CONNECTION:HARDWIRED
 CIRCUIT#2 (FANS) TOTAL AMPS:0.34 VOLTAGE:115/1/60 CONNECTION:HARDWIRED
 MODEL:MDC-83HN APPLICATION:DELI BTUH:5350 EVAP TEMP: 18°F
 DEFROST: TIME-OFF, 4/40MIN, 47° TEMP TERMINATION
 SHIPPING DIMENSIONS: 60" X 48" X 93"
 WEIGHT: 1000 LBS
 PACKOUT VOLUME: 24.23 CUBIC FT.
 INTERNAL VOLUME: 33.45 CUBIC FT.

CONFORMS TO UL STD 471.
 CONFORMS TO NSF STD 7.
 CERTIFIED TO CAN/CSA STD C22.2 NO. 120.

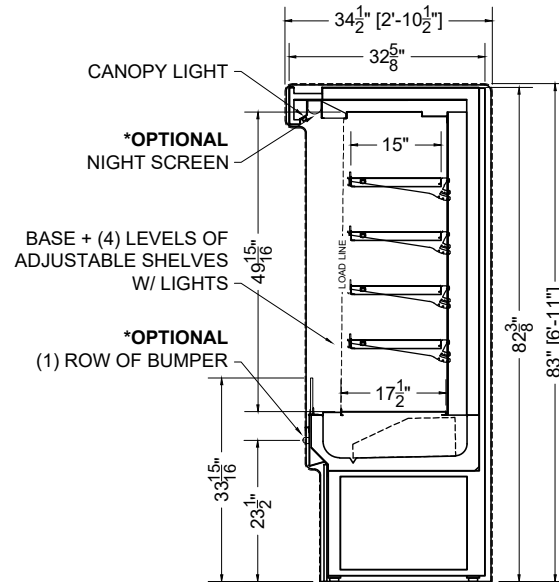

SECTION VIEW

PROJ SPECIFICATION SHEET

Des 04.0-MDC-83HN-R Narrow High Nose Multi-Deck

Name AME Dwg# 037852 Rev #01 - 11/13/23

CONFIDENTIAL DOCUMENT: THIS DRAWING IS CONFIDENTIAL AND THE PROPERTY OF SOUTHERN CASEARTS, INC AND IS NOT TO BE REPRODUCED OR EXCHANGED WITH ANY OTHER PERSON OR COMPANY WITHOUT THE EXPRESS WRITTEN CONSENT OF SOUTHERN CASEARTS, INC.

COPYRIGHT ©2023 SOUTHERN CASEARTS, INC. ALL RIGHTS RESERVED

3/8" = 1"

DRAWING DETAILS SUBJECT TO CHANGE DURING THE ENGINEERING PROCESS



SOUTHERN CaseArts