

PLAN MECHANICAL VIEW

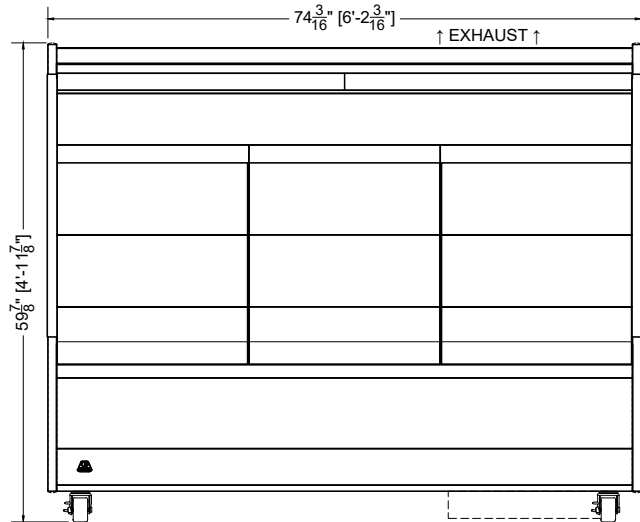

FRONT VIEW

06.0-LMRM-RPC-S PRODUCE DISPLAY (SELF-CONTAINED, 208V) CYPRESS

QTY	DESCRIPTION	PART NUMBER	VOLTAGE	PHASE	AMPS	TOTAL AMPS
1	67" LED 3500K, FROSTED, 24V	LG-FX-XXX-X	115V	1	0.13	0.13
3	EVAPORATOR FAN	RF-FA-XXXX	115V	1	0.17	0.51
1	CONDENSING UNIT	RF-CU-0388-A	208/230V	1	9.80	9.80
1	CONDENSATE EVAP PAN / 1000W / FULL	EL-EV-XXXX	208V	1	4.81	4.81

CIRCUIT#1 TOTAL AMPS: 15.25 VOLTAGE: 208-230/1/60, 3-WIRE CONNECTION: L14-20P
 * OPTIONAL COMPONENT LOAD INCLUDED PACKOUT VOLUME: 17.64 CUBIC FT. INTERNAL VOLUME: 32.36 CUBIC FT.

NOTICE: THIS DISPLAY IS NOT FOR THE DISPLAY OF POTENTIALLY HAZARDOUS FOODS.

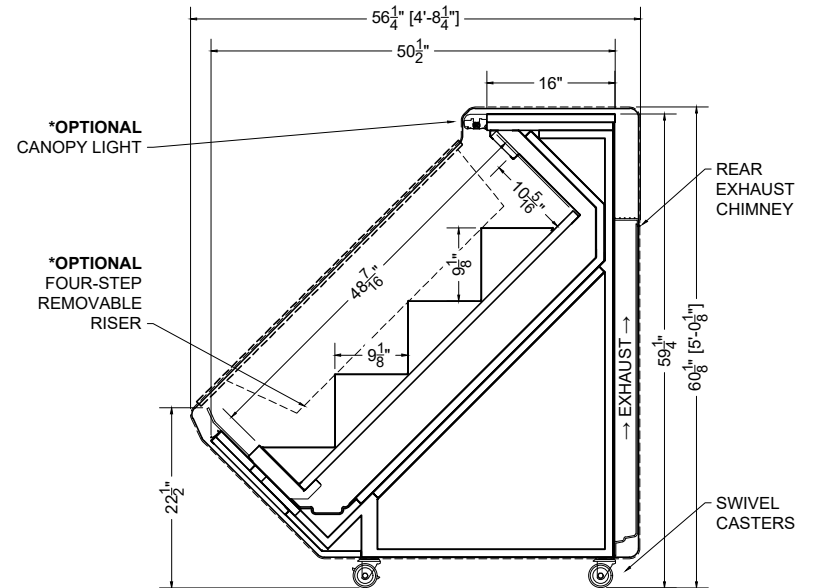

SECTION VIEW

