

PLAN MECHANICAL VIEW

12.0-BCX-SS-R

QTY	DESCRIPTION	PART NUMBER	VOLTAGE	PHASE	AMPS	TOTAL AMPS
15	45° LED 3500K, FROSTED, 24V	LG-FX-XXX-X	115V	1	0.09	1.35
5	EVAPORATOR FAN	RF-FA-XXXX	115V	1	0.17	0.85
CIRCUIT#1 (LIGHTS)		TOTAL AMPS: 1.35	VOLTAGE: 115/1/60		CONNECTION: HARDWIRED	
CIRCUIT#2 (FANS)		TOTAL AMPS: 0.85	VOLTAGE: 115/1/60		CONNECTION: HARDWIRED	
CIRCUIT#3 (CONV. OUTLET)		TOTAL AMPS: 20.00	VOLTAGE: 115/1/60		CONNECTION: HARDWIRED	
MODEL: BCX-SS		APPLICATION: BAKERY / PASTRY	BTUH: 12000		EVAP TEMP: 22°F	
DEFROST: TIME-OFF, 4/30MIN, 47° TEMP TERMINATION						

* OPTIONAL COMPONENT LOAD INCLUDED

CONFORMS TO UL STD 471.
CONFORMS TO NSF STD 7.
CERTIFIED TO CAN/CSA STD
C22.2 NO. 120.

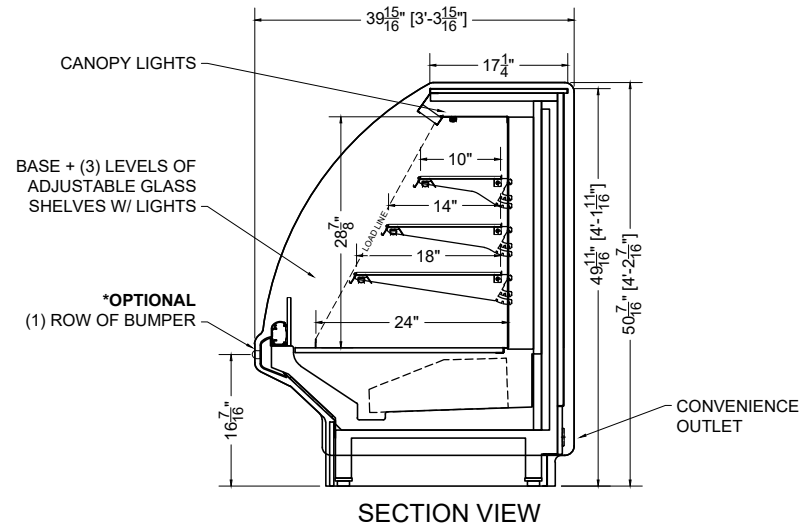

SECTION VIEW

PROJ SPECIFICATION SHEET

Des 12.0-BCX-SS-R Self-Service Bakery Case

Name AME Dwg# 037651 Rev #02 - 08/09/23

CONFIDENTIAL DOCUMENT: THIS DRAWING IS CONFIDENTIAL AND THE PROPERTY OF SOUTHERN CASEARTS, INC AND IS NOT TO BE REPRODUCED OR EXCHANGED WITH ANY OTHER PERSON OR COMPANY WITHOUT THE EXPRESS WRITTEN CONSENT OF SOUTHERN CASEARTS, INC.

COPYRIGHT ©2023 SOUTHERN CASEARTS, INC. ALL RIGHTS RESERVED

1/2" = 1'

DRAWING DETAILS SUBJECT TO CHANGE DURING THE ENGINEERING PROCESS



SOUTHERN
CaseArts