

PLAN MECHANICAL VIEW

12.0-MDC-48LS-R

QTY	DESCRIPTION	PART NUMBER	VOLTAGE	PHASE	AMPS	TOTAL AMPS
9	45° LED 3500K, FROSTED, 24V	LG-FX-XXX-X	115V	1	0.09	0.81
6	EVAPORATOR FAN	RF-FA-XXXX	115V	1	0.17	1.02

CIRCUIT#1 (LIGHTS) TOTAL AMPS: 0.81 VOLTAGE: 115/1/60 CONNECTION: HARDWIRED  
 CIRCUIT#2 (FANS) TOTAL AMPS: 1.02 VOLTAGE: 115/1/60 CONNECTION: HARDWIRED  
 MODEL: MDC-48LS APPLICATION: DELI BTUH: 9000 EVAP TEMP: 24°F  
 DEFROST: TIME-OFF, 4/40MIN, 47° TEMP TERMINATION

CONFORMS TO UL STD 471.  
 CONFORMS TO NSF STD 7.  
 CERTIFIED TO CAN/CSA STD C22.2 NO. 120.

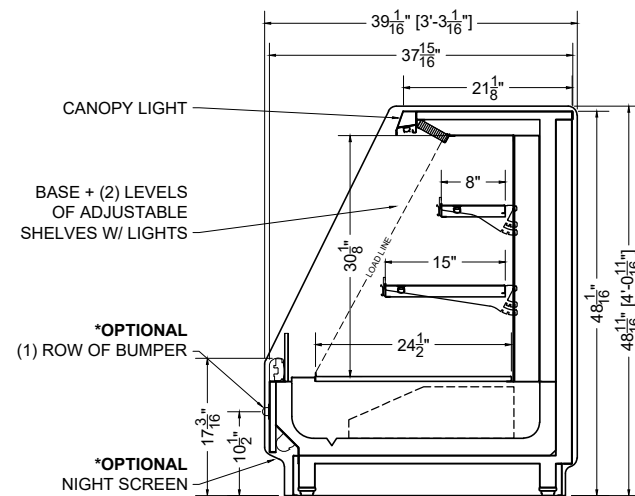

SECTION VIEW

