

PLAN MECHANICAL VIEW

08.2-MDD-87ADM-R (4 DOOR)

PLATTE

QTY	DESCRIPTION	PART NUMBER	VOLTAGE	PHASE	AMPS	TOTAL AMPS
2	45" LED 4000K 24V	LG-FX-XXX-X	115V	1	0.50	1.00
4	59" LED 4000K 24V	LG-FX-XXX-X	115V	1	0.67	2.67
4	EVAPORATOR FAN	AFXXX	115V	1	0.20	0.80
1	DEFROST HEATERS	--	115V	1	5.22	5.22

CIRCUIT#1 (LIGHTS)	TOTAL AMPS:3.67	VOLTAGE:115/1/60	CONNECTION:HARDWIRED
CIRCUIT#2 (FANS)	TOTAL AMPS:0.80	VOLTAGE:115/1/60	CONNECTION:HARDWIRED
CIRCUIT#3 (DEFROST)	TOTAL AMPS:5.22	VOLTAGE:115/1/60	CONNECTION:HARDWIRED
MODEL:MDD-87ADM	APPLICATION:DELI	BTUH:6483	EVAP TEMP: 14°F
DEFROST:TIME-OFF, 4/45MIN, 50° TEMP TERMINATION			

PACKOUT VOLUME: 109.68 CUBIC FT.
INTERNAL VOLUME: 134.33 CUBIC FT.

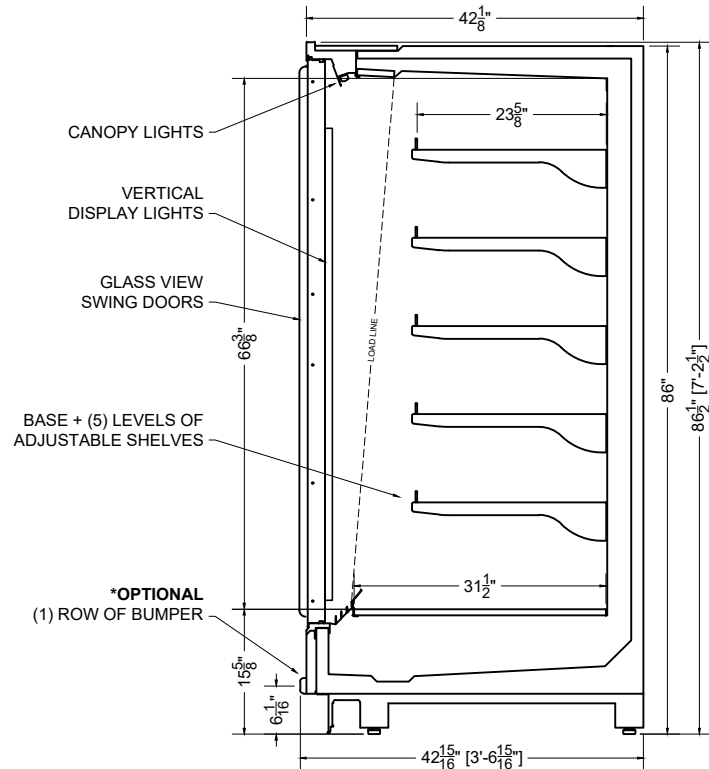

SECTION VIEW

